

TOWER WINDOWS

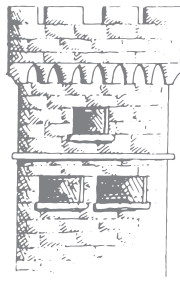

the **ultimate**[®]
collection

PVC-u and Aluminium Windows and Doors



TOWER WINDOWS

Welcome

As one of the most important decisions you will make for your property, choosing the right windows, doors or range of glazed extensions is likely to take both time and lots of research.

Having been established since 1991, the Tower team welcomes you and we are pleased to share our wealth of knowledge on a variety of products.

Throughout the following pages you will see some of our wide range of products we offer along with information about the service we provide. In our showroom you will be able to see, touch and feel all the products we offer.

Our aim is to ensure that you are able to make an informed decision about the products that suit you and your home in the best possible way. Our dedicated team of staff will be on hand to assist you in that decision making process.

We hope you find the information in our brochure helpful, and we look forward to working with you to achieve perfection for your home.

The Heart Behind our Mission

Thank you for your interest in Tower. As we proceed into our fourth decade of trading, we are incredibly proud of everything that our fantastic team of staff has achieved over the years.

From the early days the Tower ethos was to build a company which would always try to look after and be fair to everyone our business had dealings with, whether they were clients, staff or suppliers.

Looking back, we truly believe that making that commitment has stood Tower in good stead and is the bedrock of all that we have achieved. There is no question that we have been extremely fortunate to have such a great team of people working with and supporting us.

We would like to think that all of the Tower team are like an extended family. Some of our staff started with us over 25 years ago and have worked and grown with the business. It fills us with great pride to see staff grow into brilliant team players. It is that ethos of helping staff develop that means we have been able to maintain the high levels of client satisfaction that we set out to achieve.

We will continue to focus on promoting the same values that have endured for so long, looking after people, being fair and offering a great service along with offering first class and innovative products. This is what Tower is all about, and that mantra is at the core of our business and why we continue to succeed through challenging times.

We hope you enjoy your experience with Tower and once again thank you for contacting us.



PVC-u Casement Windows

An initial choice you will want to make when considering new windows, is whether to have bevelled or ovolo shaped profile. Bevelled profile offers contemporary clean lines whilst ovolo profile offers a more detailed, sculptured finish. This decision is largely down to personal preference and can often be influenced by the style of your property and others surrounding it.



Bevelled Profile



Ovolo Profile



Versatility in Design

In order to cater for the diverse mix of property styles and consumer preferences, windows and doors are now available in a wide variety of styles and finishes.

Using a combination of top openers, side openers and fixed panes, the range of styles is immense so you are sure to find a design to suit your home.

There is no reason to compromise when replacing bay windows either. The Ultimate Collection offers load bearing support components to suit both 90° bay windows and multifaceted bays.



Trickle Ventilation

As of 15th June 2022, Approved Document F of the Building Regulations that specifically relates to ventilation, requires that adequate ventilation is provided throughout a property.

Adequate ventilation will ensure that air flows through the property by allowing stale air and harmful pollutants to escape, helping to reduce the spread of airborne viruses whilst maintaining a good level of air quality, particularly important to allergy sufferers and those with Asthma.

Ventilation is also crucial in helping to prevent the accumulation of excess condensation which could have an adverse affect on the structure of your home and your health. In the absence of a suitable mechanical ventilation system, conforming to these regulations requires the use of trickle vents fitted into windows.

Ultimate Collection Windows are able to meet these requirements with efficient, safe and secure trickle vents, installed into either the sash or outer frame.

Ventilators match to your chosen frame colour and the hooded external canopy prevents water and insects from entering the home.

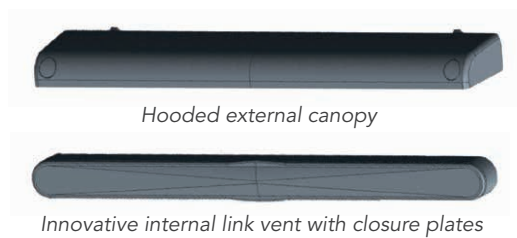

Trickle Vents installed through the window sashes



*Trickle Vents installed through the outer frame
Also showing the functionality of the internal link vent closure plates*

Concealed Ventilation Canopy

You also have the option of concealed ventilation.

The ventilation is built into the head of the outer frame which is concealed by a full width aluminium exterior canopy, colour and finish matched to your window frames.

The same interior link vents with closure plates, as used above, are used on the inside of the window.



Concealed Ventilation installed through the outer frame

Importance of the finish

With the rapid advancement in PVC-u technology, you would often now be hard pressed to tell the difference between PVC-u products and their timber equivalents.

This provides you with a multitude of finish options, all of which will require minimal maintenance in comparison to the timber equivalent.



Dark Grey 7016 Woodgrain



Agate Grey finish - See Heritage Style



Ice Cream Woodgrain ovolo windows with Georgian bar detail



Close up showing the realistic black woodgrain effect on ovolo profile



Grey bevelled profile working well with cream exterior render



Rosewood Finish on Bevelled Profile

Options now extend far beyond the traditional white window.

The Ultimate Collection offers you so much choice in terms of style and finish that you should never need to compromise.

You may find for example that choosing a Rosewood or Oak woodgrain finish will help to blend more sympathetically with your home and garden.

Colours such as Black, Grey, and Cream are also increasingly being used to great effect as well as an array of other woodgrain finishes.

And remember, unlike their timber equivalents, they will not need painting, and they will be guaranteed for years to come.

Finish Options

Ultimate PVC-u Windows and Doors are available in a wide range of finish options.

Scan here to view...





Ali-lock Authentic External Georgian Bar option

You may decide to have decorative Georgian Bars applied to your windows for the truly authentic Georgian style.

The unique Ali-lock Georgian Bar is a scribed PVC-u bar, finished and colour matched to the exact same finish of your chosen windows. The bars are connected to full length aluminium fixing strips that are bonded to the glass unit. This, combined with the spacer bar grid design inside the unit, gives the impression that each pane is a separate unit.



The innovative Ali-lock bar system ensures the Georgian grille does not shrink, warp or detach, regardless of weather conditions.



Internal Georgian Bar

In contrast to the Ali-lock External Georgian Bar system where the bar is applied onto the outer faces of the insulated glass unit, as the name suggests, Internal Georgian Bars are held within the sealed glass unit.

Internal Georgian Bars still provide an effective feature but with the bars inside the glass, the glass maintains a flat surface with no protrusions and are therefore easier to clean.

Maximise the opening with a floating mullion



The owners of this property wanted to maximise the size of the opening of the kitchen window. The solution was a cottage style window complete with a floating mullion. The floating mullion is purposely designed to house the locking system so a central fixed vertical mullion is not needed between the two opening sashes. When the windows are fully open, you get the maximum benefit and when the windows are closed, the floating mullion gives the appearance of a fixed frame between the two opening sashes.



The floating central mullion allows the windows to benefit from the maximum opening without the obstruction of a fixed vertical frame between the opening sashes

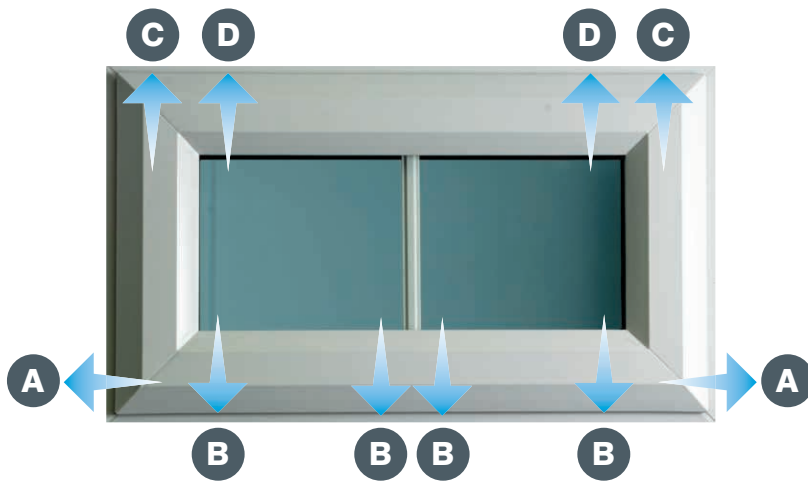

A total of 10 security points around each opening window



BS 7412/PAS 24
KM 36015

2 x steel shoot bolts*

4 x central collared cams

2 x high security fire escape / easy clean hinges

2 x 15mm anti-jemmy hinge bolts



Steel Shoot Bolts*



Collared Cams



High Security Fire Escape / Easy Clean Hinges



15mm Anti-jemmy Hinge Bolts



Smart Safety Solutions

For your safety, high security fire escape / easy clean hinges are fitted as standard to all side-opening windows. These will open fully to give you an alternative means of fire escape (dependent on window size) and can slide towards the centre to allow easy external cleaning.

'PRESS' the release clips located on the top and bottom hinges and simply slide the window across for easy external cleaning. The window will automatically realign upon closing.

The release clip is clearly marked with the word 'PRESS' as shown right.



Fire escape / easy clean functionality

* Shoot bolt and night vent functionality are dependent on the dimensions of an opening sash. Therefore small sashes may not have one or both of these functions. Limited night vent locking available on French Casement windows; master sash only on rebated sash French Casements and none on flush sash French Casements.

Energy Efficiency



In order to meet the governments thermal performance targets and current Building Regulations, all replacement PVC-u windows are to achieve a U-value not exceeding 1.4 (W/m².K), therefore certified to Energy Rating 'B' or better on a scale from A++ down to E.

Ultimate Windows achieve an A+ Energy Rating with an Energy Index of 10 and a U-value of 1.4 (W/m².K).

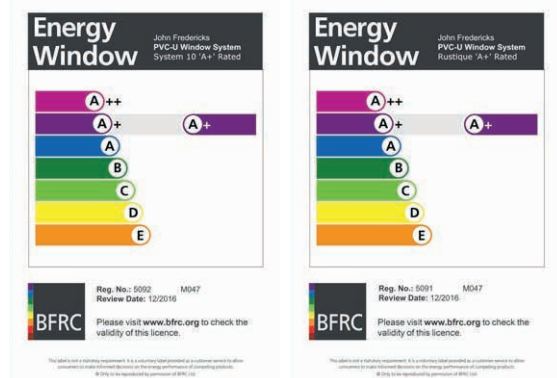

The red glow shown left, on the internal face of the entire window area symbolises the amount of heat Ultimate windows retain.

As a result, the inside of your property remains warmer and more energy efficient.

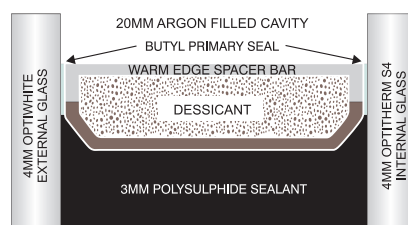
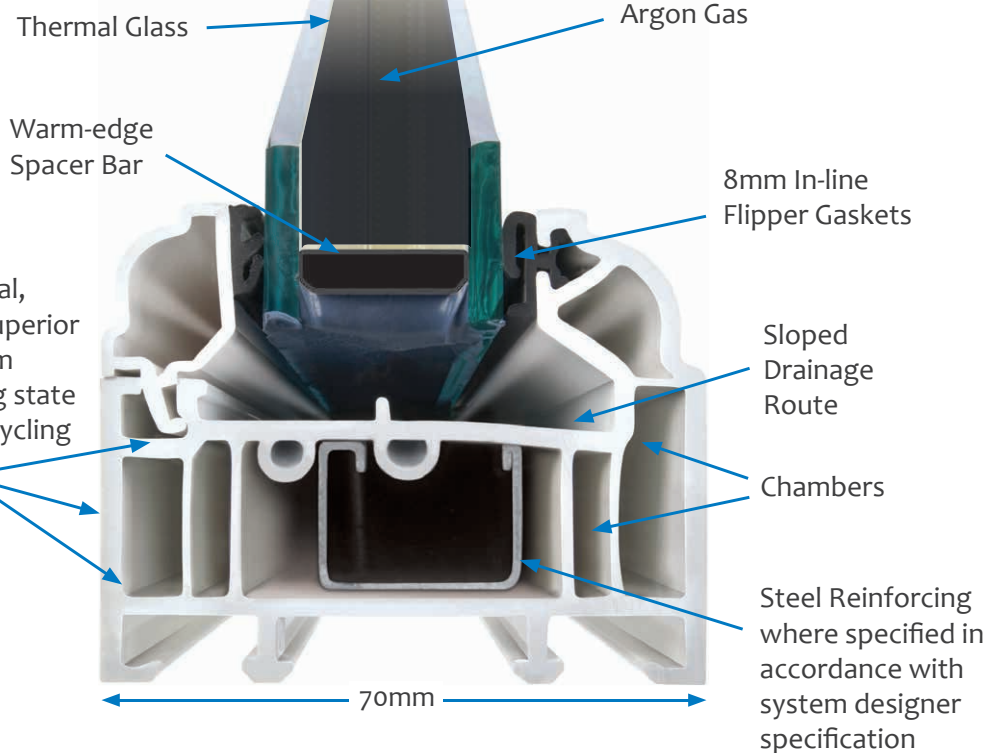
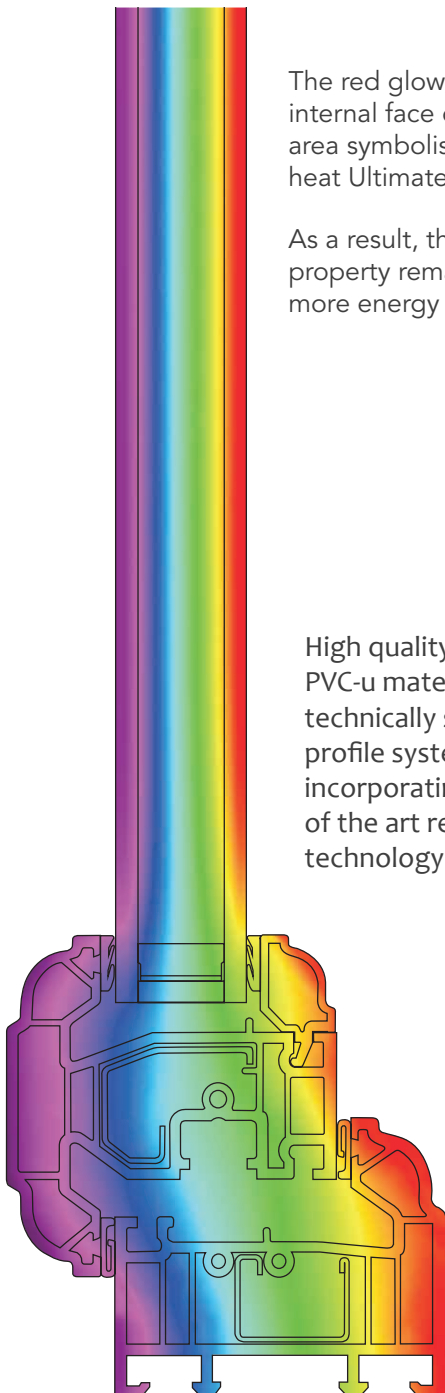

Typical A-Rated Sealed Unit

Reduce home heat loss and save money with Ultimate Energy Efficient Windows.

Heritage Timber-look Windows



The Ultimate Heritage Collection is designed to offer an innovative, low maintenance yet high performance alternative to traditional timber joinery.

A crucial design aspect that helps to create the timber look is the use of 'dummy sashes' where no opening window is required.

An example of this is pictured right where the two outer sashes are designed to open but the middle sashes do not. 'Dummy sashes' are used in the middle to give the impression of an opening sash and consequently keep the appearance identical to the two outer opening sashes.

The use of 'dummy sashes' is standard across the Ultimate Heritage Collection and ensures a balanced design with equal sight lines throughout.



The Ultimate Heritage Collection offers you the choice of three sash styles. All 3 Heritage options include dummy sashes on any fixed windows, providing equal sightlines.

HERITAGE REBATED SASH



The **Rebated Sash** option has a bevelled profile on the outside but with ovolo detailing on the inside.



45° corner joints



White Woodgrain internal finish

HERITAGE FLUSH SASH



The **Flush Sash** option, as the name suggests offers casement windows that sit flush within the outer frames, 45° corner joints and white woodgrain ovolo detailing on the inside.



45° corner joints



White Woodgrain internal finish

HERITAGE GENUS FLUSH SASH



The **Genus Flush Sash** option takes the timber look one step further with scribed and milled butt joints to the outer frame and sash for the truly authentic timber look.



Scribed and milled corner butt joints



White Woodgrain internal finish



Heritage Rebated Sash

For a cottage style appearance, the Ultimate Heritage Rebated window, finished in one of the available subtle woodgrain colours such as Ice Cream or French Grey will add charm and character to a property.

Optional Georgian Bars will enhance the character further and provide a strong sense of period identity, particularly important if you are replacing 'like for like' and trying to emulate the traditional timber joinery that you are replacing.





Elegance and simplicity with the Ultimate Heritage Flush Sash

Ultimate Heritage Flush windows may be the ideal solution if you want to give your house the wow factor but stay sympathetic to the style of the property and others surrounding it.

The flush casement style, shown here in Ice Cream woodgrain finish, creates the impression of wooden windows. As with all Ultimate Heritage woodgrain windows, the inside face is kept to a neutral White Woodgrain finish for a bright and spacious feel and to complement neutral décor.

Two horizontal Georgian bars add character to the property and reflect the traditional styles of many of the houses in the same village. To the rear of the property the owners wanted an uninterrupted view of the garden, so decided not to have Georgian bars on those windows.





Subtle colour palette with a Woodgrain finish, combined with clean bevelled lines and sashes that sit perfectly flush within the window frame.



Elegant external putty line Georgian bars to add character and complement the style of the windows and the surrounding property.



Neutral and fresh White Woodgrain internal finish, with ornate sculptured detail around the frame and Georgian bar layout.



The Ultimate Heritage Collection offers you a timber look PVC-u cill option, deeper in proportions to standard PVC-u cills in order to complete the timber look.

Genus Timber-look Joinery

For the ultimate timber look window, you have the option of choosing the Heritage flush sash complete with Genus joinery. These windows look, feel and are made just like their timber counterparts.

Scribed and milled butt joints to both the inside and outside of the outer frame and sash make it difficult to distinguish these from timber windows.



Concealed Ventilation Canopy

Heritage windows also offer you the option of concealed ventilation. The ventilation is built into the head of the outer frame which is concealed by a full width aluminium exterior canopy, colour and finish matched to your window frames.





Window handle options



White



Black



Graphite



Gold



Chrome



Satin



Bronze



Antique Black



Chrome
Teardrop Handle



Gold
Teardrop Handle



Graphite
Teardrop Handle



Antique Black
Teardrop Handle



Chrome
Monkey Tail Handle



Gold
Monkey Tail Handle



Graphite
Monkey Tail Handle



Antique Black
Monkey Tail Handle

Tilt & Turn PVC-u Windows

Windows are sometimes positioned above a work top where you have to reach across to open and close the window. Or perhaps there is restricted space outside where it may not be ideal to have a window opening outwards.

In these situations you may want to consider an inward opening Tilt/Turn window. These are designed to tilt inwards for ventilation then open in 90° for easy clean access. Optional 180° opening available upon request (with surface mounted gearing).



Tilted Inwards



Open Inwards



Bespoke PVC-u Doors

Choosing the right entrance door for your home is an important decision as your front door creates the first impression and the all important kerb appeal.

Your choice of door and glazing design can help define the overall style of your home and add light to an otherwise darkened hallway.

Whether it be traditional or contemporary you are sure to find a style that suits. Ultimate doors give you almost endless style and colour choices.

If you would like a door colour that is not within our standard range of colour options, we can arrange to have your chosen door design spray painted in the colour of your choice.

With the vast choice of finish options and an elegant range of glass and door furniture, it's now possible to emulate most timber door styles in PVC-u.

The Lavenham



Lavenham door with deep feature midrail and Genus butt joints



Lavenham door design with sidelites and toplites



Lavenham door with Barite Glazing top and middle



The Ixworth

A period style reminiscent of 1930's timber doors



The Ixworth 2

Adaption of the Ixworth with 2 vertical mullions



The Sudbury

A Classic style, suited to most properties



The Assington

The country cottage look

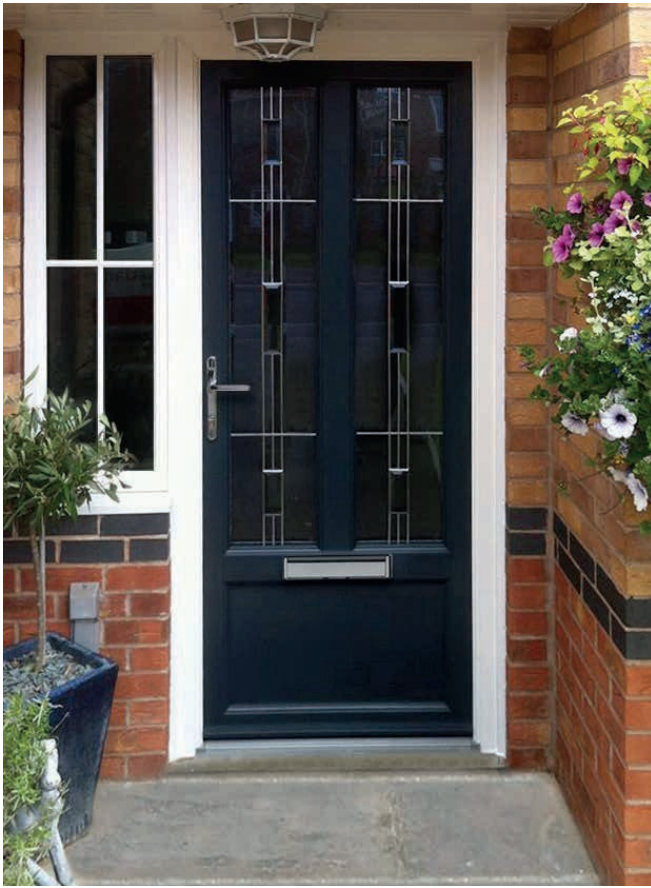

The Newton

Exaggerated Barite glass panels provide more light



The Cornard

Half glazed



The Brett

Contemporary style, complete with Satin glass



Furniture Options

You are able to choose from a variety of door handles, letterplates, pull knobs and door knockers.

Scan here to view...



PVC-u Door Style Selector



Yeldham



Cornard



Melford



Sudbury

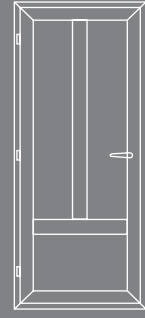

Newton

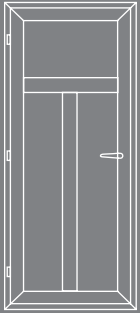

Kersey



Ixworth



Ixworth 2

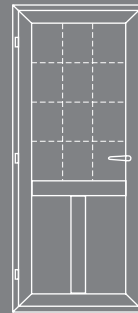

Boxford

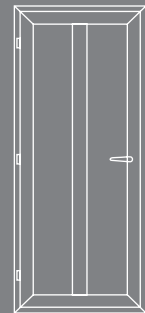

Belchamp



Pebmarsh

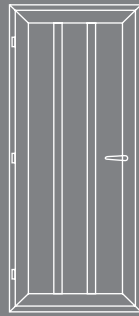

Hedingham



Gosfield



Assington

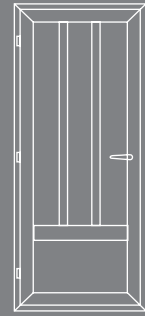

Depden



Lavenham



Hartest

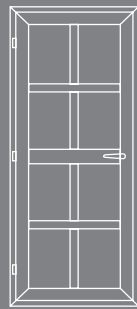

Cavendish



Bures



Nayland



Colne

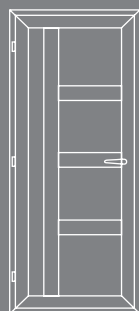

Brett



Polstead



Hadleigh



Stour

Decorative Glazing

Coloured and bevelled glass designs can offer a traditional appearance, whilst more simplistic etched glass designs give a contemporary look.

The dimensions of these glass patterns can be adapted to suit the style of your chosen door with half, dual, and full height glazed panels.

You may wish to personalise your home further by having your house number etched or bevelled within the design.



Full Height
Glazed Panels

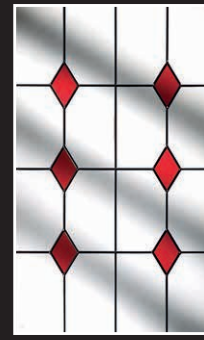

Half Glazed
Panels



Dual/Quarter
Glazed Panels

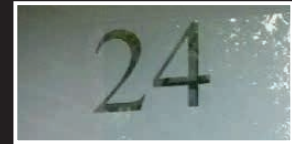

Etched house number



SD1G



SD2G



SD3G



SD4G



SD5G



SD6G



SD7G



SD8G



SD9G



SD10G



SD11G



SD12G



SD13G
Fully Etched



SD14G
Etched with
clear border*



SD15G



SD16G

The above designs are for guidance only, please speak to your consultant for advice on the full range of options.

The above designs are for 28mm double glazed units with any bevels attached to clear glass combined with a backing glass of choice.

*SD14G Etched background with 15mm wide clear border positioned 25mm from visible edge of glass.

Bespoke PVC-u Door Features

Optional Deep Timber Look Midrail

Ultimate Bespoke Doors are engineered with a slimline midrail as standard in order to achieve equal sight lines and proportions across the range of styles.

However, a number of styles in the collection have been designed to closely emulate traditional timber doors and are therefore best suited to include a deeper Midrail option.

Ultimate Bespoke doors give you the additional options of the two section 168mm Midrail or one section Deep Timber Look 195mm Midrail*.



Standard
Midrail Depth



168mm
Midrail



195mm
Midrail



Optional Deep Timber Look Cill

The timber style features can be carried right through to the cill.

Ultimate Bespoke Doors offer you the option of a timber look PVC-u cill, deeper in proportions to standard PVC-u cills in order to complete the timber look.



Genus Timber-look Joints

For the authentic timber look, Ultimate bespoke doors offer you the option of Genus timber-look joints inside and out.

An alternative to 45° welded joints, these are designed to emulate the traditional butt joints seen on timber doors.

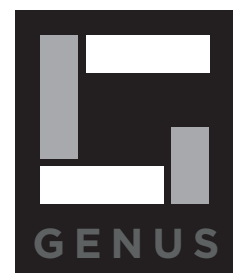

*Midrail options may be determined by frame and colour choice.

Up to 14 security points around the door

- 2 x top and bottom shoot bolts.
- 3 x outer/inner facing hook locks.
- 2 x dead locks.
- 1 x centre locking latch.
- 4/6 x roller cams (dependent on door height).
- Plus 2 x anti-jemmy hinge bolts.



BS 7412/PAS24
KM 590739

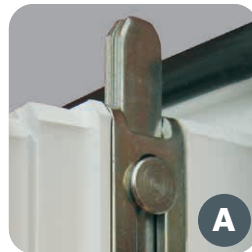
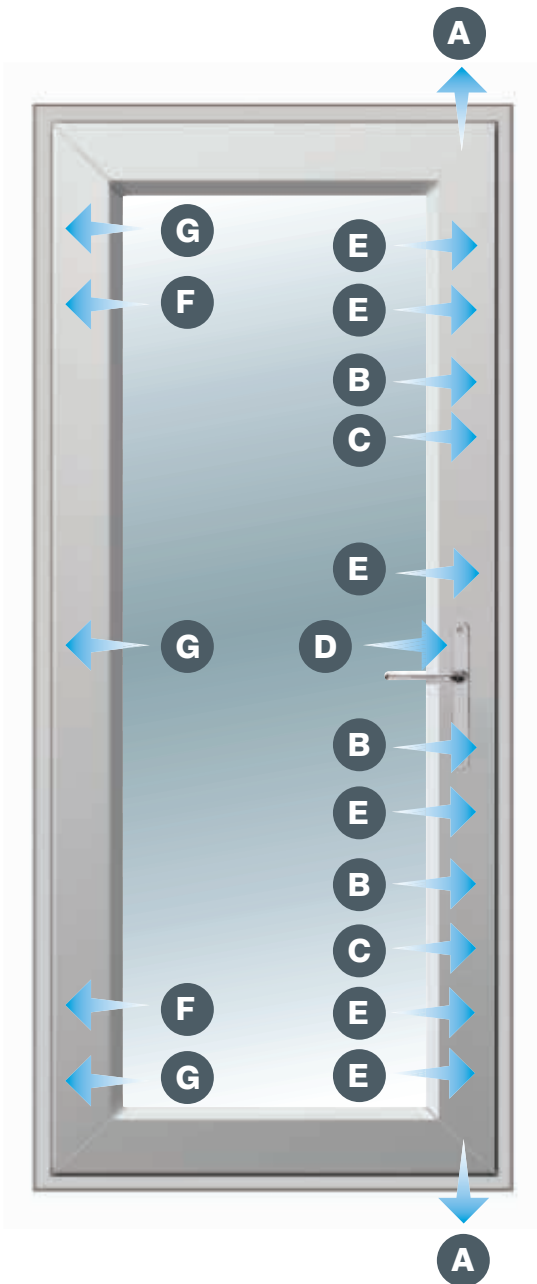

Shoot Bolts



Hook Locks



Dead Locks

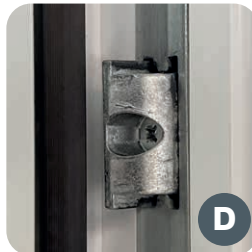

Centre Locking Latch

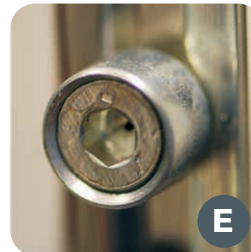

Compression
Rollers Cams

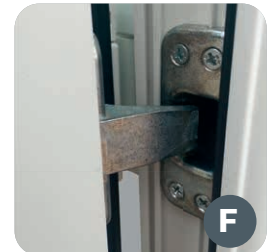

Anti-jemmy
Hinge Bolts

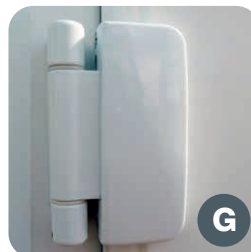

Standard Hinge
(other finishes available)



Optional Pencil Hinge
(Heritage Doors Only)

Yale High Security Cylinder

To prevent cylinder manipulation, Ultimate doors are fitted with a 3 star high security Yale cylinder, and for convenience all doors are supplied with 5 keys as standard.



Townhouse Lock

As an alternative to the standard locking system, you may wish to consider our townhouse lock option. The townhouse lock is completed with a traditional escutcheon finger pull. This option includes the same high security cylinder as detailed left.



PVC-u French Doors

French Doors, often with full height glazing can provide additional light to a room. They are used both internally as a partition from one room to another or externally to provide elegant access to the garden.

These door styles will also provide a practical wider opening, particularly useful when moving larger items to and from the property. When the opening is too narrow for a Bi-fold or Patio Door, French Doors can often be the perfect solution. All Ultimate French Doors include the same multi-point lock that is fitted to single doors with additional shoot-bolts fitted to the slave door.



PVC-u Stable Doors

Contemporary Stable Door

The contemporary stable door option is a hybrid, encompassing the lower half of a standard residential door, with the top half of a tilt and turn window.

The tilt and turn section works independently so you are able to either tilt the top opening sash inwards (hinged from the bottom), or have the top opening sash fully open and hinged from the side.

The doors can be inward or outward opening but the tilt and turn function is always inward opening.

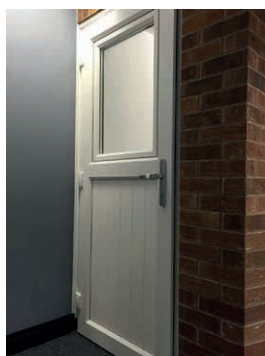

Closed Position

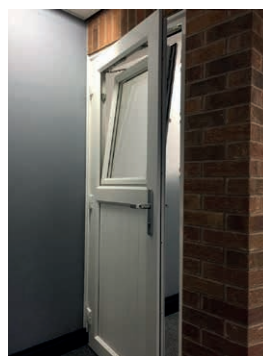

Tilt Position



Turn Position

Traditional Stable Door

As the name suggests, this option works in the same way as a traditional timber stable door. Unlike the contemporary option the proportions of the door are a 50/50 split with the top and bottom half equal sizes.

This option also operates in the manner of a traditional stable door and does not have the same tilt and turn functionality as the contemporary option.



PVC-u Sliding Patio Doors



Modern day comfortable living comes in a variety of forms. Where light and space is key, large glass surface areas such as Sliding Patio Doors will help to bring in more light and provide that contemporary spacious feel.

They are particularly suited to rooms restricted in size or space with the doors sliding horizontally and therefore not encroaching on internal space.

Security is covered with opposing hooks locks, internal/external locking, aluminium inter-lock section and anti-lift device. Secured By Design is an optional extra.



Composite Doors

The **Ultimate Original FOAMCORE 44mm Composite Door Collection** offers a range of high security doors, with styles from the traditional through to contemporary and in a multitude of colour options.

You are sure to find a door style that will enhance the both the look and thermal performance of your home. Please refer to the full Ultimate Original FOAMCORE 44mm Composite Door brochure for the complete range of options.



3 Square
Monza II, Flush & Links



4 Square
Monza II, Flush & Links



Augusta
Monza II, Flush & Links



Augusta Long
Monza II, Flush & Links



Belfry

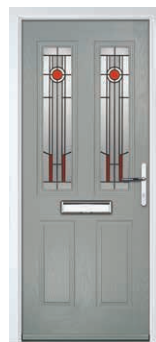

Carnoustie



Troon



Lytham



Lytham 4 Grid



Merion



Merion Grid



Monza II Solid



Muirfield



Vilamoura
Flush & Links



Muirfield Solid



Oakmont
Monza II, Flush & Links



Pevero



Pinehurst



Portrush



Portrush Sunburst



Sunningdale



Riviera



Seminole 4
Flush & Links



FOAMCORE

See our full **Ultimate Original FOAMCORE 44mm Composite Door Collection** brochure for more information on the complete range of available door styles.

Scan here to view...



Introducing an innovative hybrid technology of composite doors

In addition to the 'FOAMCORE' range of Composite Doors, you have the innovative option of **SOLICORE Composite Doors**.

SOLICORE is a hybrid of modern and traditional materials and has been engineered to deliver a door that is stronger, more rigid and thermally stable than anything on the market.

The solid inner core consists of 3 layers of cross laminated engineered hardwood, encased with LVL (Laminated Veneer Lumber) and hardwood stiles and rails for protection against any water ingress, then pressed with SOLICORE's signature 4mm GRP skins.

The result is a door that will not crack, move or de-laminate, requires minimal maintenance and will look beautiful and protect your home for years to come.



SOLICORE

- 44mm door engineered to the highest specification
- 3 layered engineered hardwood inner core
- 3mm maximum thermal movement
- No cracking or de-lamination
- Bespoke designs, glass, glazing cassettes and colours available

See our full **Solicore Door** brochure for further details.

Scan here to view...



Inside a SOLICORE door

Encased LVL (Laminated Veneer Lumber) & hardwood stiles and rails for stability and protection against water ingress.

3 layered inner core of cross laminated engineered hardwood, creating a stronger, heavier and more robust door, that offers exceptional results when it comes to thermal efficiency too.

SOLICORE's signature 4mm GRP skins are pressed onto the core with a unique method, ensuring flawless correlation with the core. Available in three finishes that can be painted any colour, they are a stylish, formidable barrier that requires minimal maintenance.

6 Point Locking Security

Whether you choose an Ultimate 'FOAMCORE' or 'SOLICORE' Composite Door, both are fitted with a robust multipoint lock with 6 locking features. Simply by lifting the handle upwards, all locking features are engaged.

High security hinges and a Yale cylinder completes the security and ensures the door seals tightly with little effort.

An Automatic lock option and Townhouse lock option are also available. Please see the full brochure for details.



**3 Dead Locks
2 Hook Locks
1 Centre Latch**



**Hinges
(other finishes available)**



**Hinge Bolts
(optional)**

Aluminium Windows & Doors

Slim frames maximise light intake

The PANORAMA slimline aluminium window has been designed specifically to meet the needs of UK households. This unique and expertly engineered window suite offers the discerning homeowner the perfect combination of exceptionally slim frames and the highest levels of performance.

With sleek, clean lines, these beautifully designed windows can transform the appearance of any home, adding value to the property whilst also making it warmer, brighter and more secure.

Perfectly complementing both contemporary and traditional styles of property, the PANORAMA window is stylish and timeless in its design.

With an impressive 65mm sash to frame width (depending on outer frame choice), PANORAMA's clean lines provide a stylish yet practical solution, mimicking the sight lines of original steel-framed windows. The frame depth of 68mm makes them perfect replacement windows to fit within the existing plaster lines.

Glazing can be from the inside or outside and is available in various thermal options, double or triple glazed up to a maximum depth of 36mm. Also available as a full flush casement for a more traditional look.

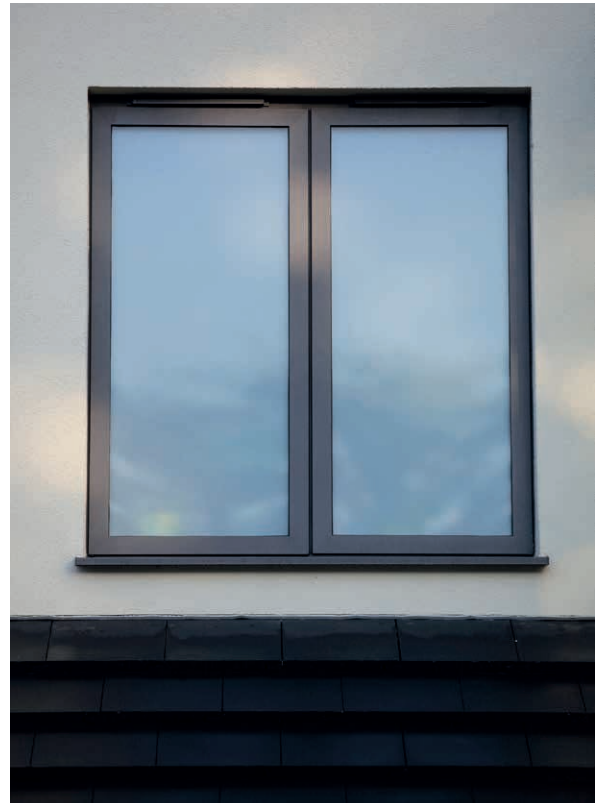

Tried and Tested

The PANORAMA slimline window was designed by a highly experienced team of engineers in a purpose-built, world-class design and testing facility. This window has been put through the most stringent test regime, ensuring that it is one of the highest-performing and most reliable window systems available.

- Premium quality materials
- Highest levels of performance
- Industry-leading weather resistance



Warm and Cosy

One of the most noticeable differences for many homeowners is how warm and cosy their home feels once their new windows and doors are in place.

PANORAMA is designed to offer class-leading insulation levels without compromising on the appearance of the window.

The result is a window that will keep heat loss through the window to a minimum, withstand the worst that the British weather has to throw at it, and will help keep your energy bills down.

Peace and Quiet

Not only is the frame of the PANORAMA window designed to help eliminate unwanted noise, the system is also flexible enough to allow a glazed unit up to 36mm thick to be specified.

This makes it possible to incorporate fairly sophisticated acoustic glazing, which makes a huge difference if you live near a busy road, a railway or an airport.

Safe and Secure

PANORAMA windows are designed and tested to the most stringent security standards.

Knowing that your window can be upgraded to achieve PAS24 means you can rest assured that your home, your family and your prized possessions are as safe as can be from would-be intruders.

- *One of the most secure windows available*
- *PAS24 (Optional Extra)*
- *Enhanced security with hinge-side security brackets*
- *Multi-point locking mechanism*
- *Lockable handle*

Standard Finish Options

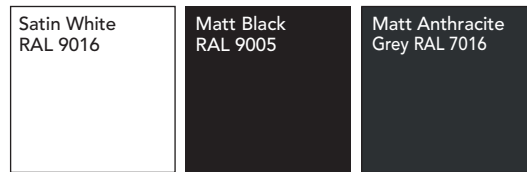

Extended Range



Due to possible variations in the printing process, please refer to physical colour swatches for an accurate representation of the above finish options.





Choice of 3 Window Styles

- Available in a choice of Contemporary, Flush or Heritage Window styles
- Choice of glazing materials in single, double or triple skin
- Weathertight gaskets
- Thermal break

Contemporary Window (Standard Outer Frame)

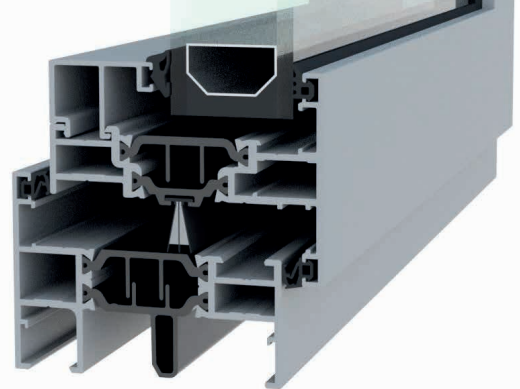

Flush Window (Standard Outer Frame)

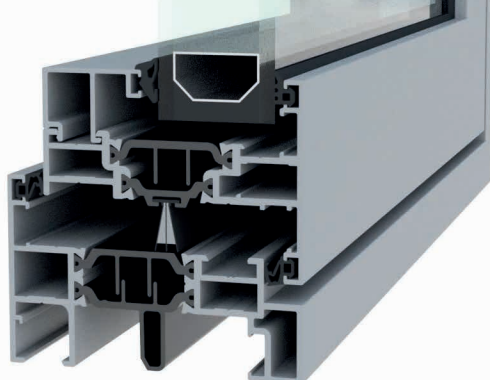

Heritage Window (Standard Outer Frame)

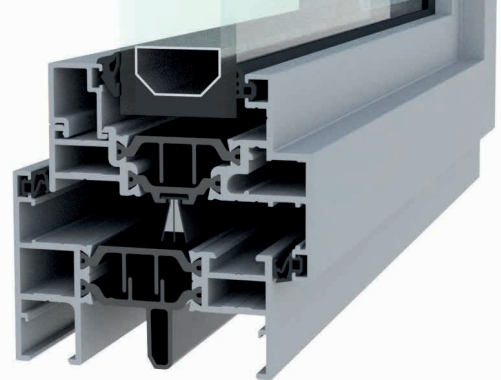

Aluminium Bi-fold Doors

Designed for modern day living

Over time we have changed the way we use our homes. There has been a shift towards large open plan spaces, particularly with combined kitchen and dining areas where we spend so much of our time. Equally, the distinction between indoor and outdoor living has become less defined with a common emphasis now placed on how the home flows from inside through to the garden.

Bi-fold doors are the perfect solution for those wishing to maintain the sense of light and space in the home and when the weather permits open up fully into the garden.

PANORAMA Bi-fold doors can be designed with up to 6 panes and in a variety of folding configurations. Should you want to, a single traffic door can be specified left or right to give access in and out without the need to open up the full width of the door.

Innovative features and benefits

- Slim frames providing maximum light
- Doors fold neatly to maximise opening
- Double or Triple glazed options
- Security to British and European standards
- 6 point lock as standard (optional hook lock: 2 hooks, 1 deadbolt and latch)
- Inward or outward opening
- Four threshold options
- Water resistance up to 600 Pa
- Up to 6 door leaves
- Maximum height 2412 mm
- Maximum door leaf width 1200 mm
- High spec stainless steel rollers
- Range of handle finish options
- 3 star high security Yale cylinder
- Sealed unit depths from 28-36 mm



Opening Configurations

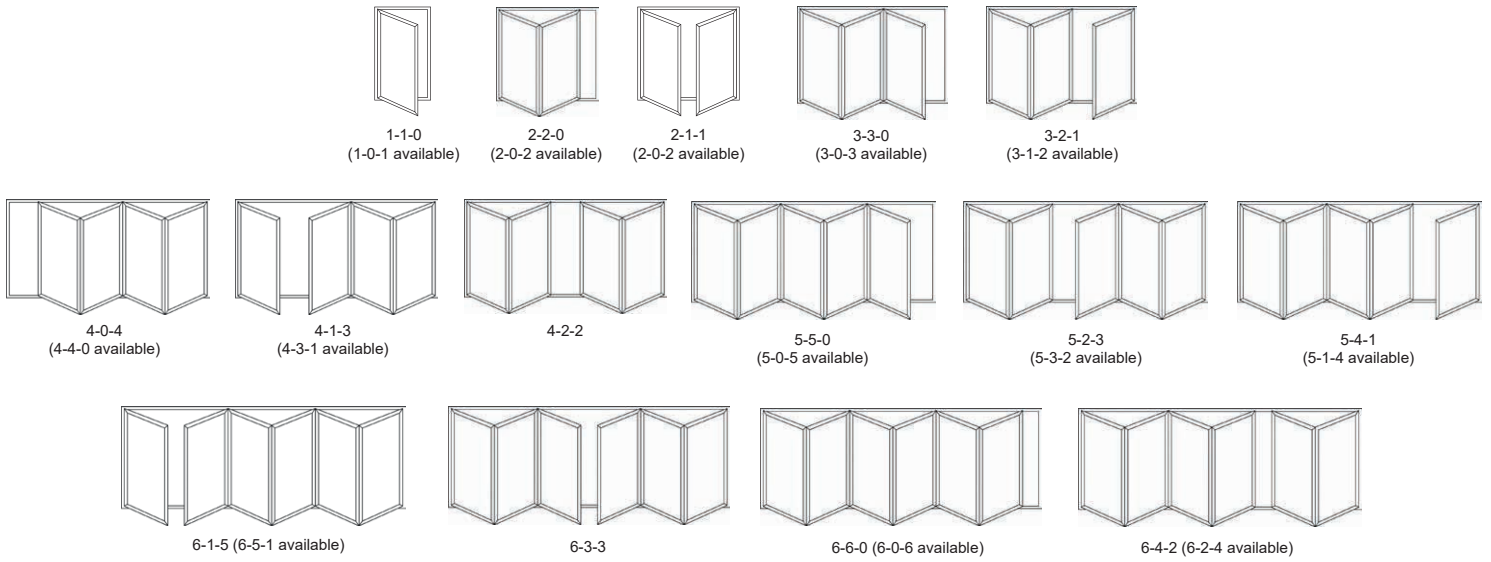

Standard Finish Options

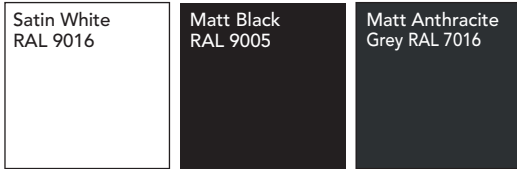

Extended Range



Bi-fold Door Furniture



Standard Handle

Intermediate door leaf handles



Centrefold D-Handles

Due to possible variations in the printing process, please refer to physical colour swatches for an accurate representation of the above finish options.



Aluminium Lift & Slide Patio Doors

Aluminium lift and slide doors

This versatile door creates an extra feeling of space and generates more natural light within the home.

PANORAMA is a premium insulated sliding door system combining high weather performance with enhanced security and great aesthetics.

With a lift and slide mechanism, this sliding door system is designed with ease of use in mind.

The system not only glides smoothly, it also has a slimline mid-section interlock to maximise the glass area.

With a maximum vent weight of 300 kg and a maximum height of 2.5 m, this versatile system is ideal for most residential applications.

Thermal insulation is important for most people. PANORAMA doors offer industry-leading performance in this respect.



Standard lift and slide handle options

Our Lift and Slide Patio Door handles are available in the same 5 colour finishes, with finger pull cups to match:



White

Polished
Stainless Steel

Satin Chrome

Anthracite Grey

Black

Lift & Slide Door Configurations

Choose from a twin track or triple track system, depending on the width of the opening and your preferred configuration of fixed panes and sliding doors.

TWIN TRACK OPENING CONFIGURATIONS

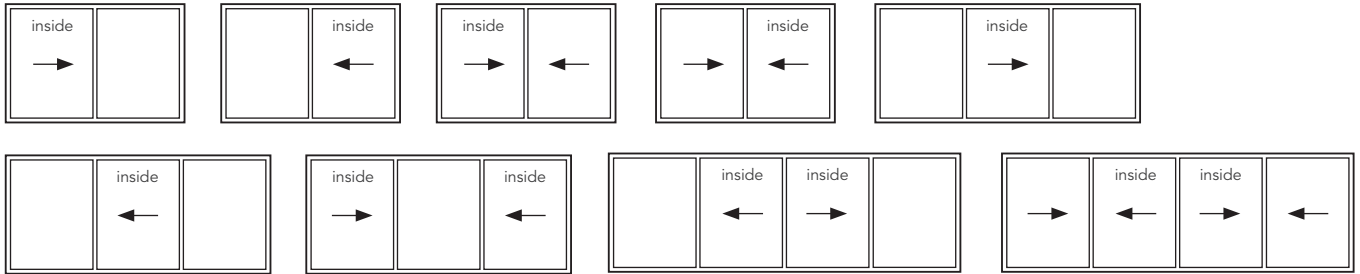

TRIPLE TRACK OPENING CONFIGURATIONS

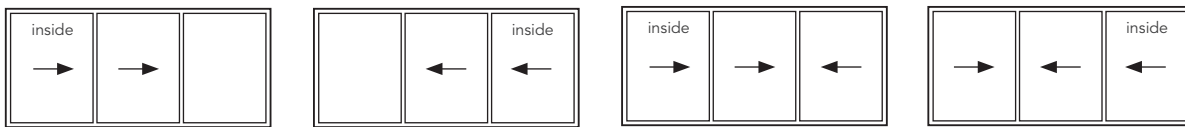

*'inside' denotes slider on internal track

- Lift and slide operation
- Effortless operation with up to 300kg maximum vent weight
- 4 point locking system
- 10 Year Guarantee
- Stainless steel rollers
- Anti-stick Teflon coated gaskets
- Slimline mid-section interlock
- Twin or Triple track sliding options
- Sealed unit depths from 28-36 mm



Standard Finish Options

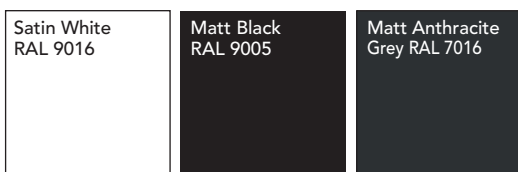

Extended Range

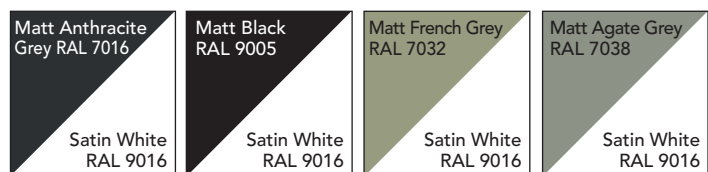

Due to possible variations in the printing process, please refer to physical colour swatches for an accurate representation of the above finish options.

SuperSlim Aluminium Windows



PERFORMANCE & AESTHETICS

Panorama SuperSlim Windows offer minimal sightlines for maximised views. With optional PAS24:2022 certification, the Panorama SuperSlim Window exceeds Part L compliance with a WER rating of A, and a new build requirement of 1.4 W/(m²k) is achieved when combined with highly energy efficient glass.

The Panorama SuperSlim Window is available in two distinct designs. The 'Contemporary Sash' design, which features a sleek and modern look with a 73mm frame depth. This system can be seamlessly integrated with our SuperSlim Bi-Fold when side panels and flag windows are required, offering versatility and consistency in your window and door solutions.

Alternatively, if you are looking for a more traditional appearance, the 'Flush Sash' design might be the ideal choice for you. With a frame depth of 81mm, this system exudes a classic and timeless charm, adding a touch of elegance to any property. Both designs offer exceptional quality and performance, and we are confident that you will find the perfect fit for your project.

TECHNICAL PERFORMANCE

- SuperSlim Profile Sections
- 28mm Double Glazing (Standard)
- Alternative 44mm Triple Glazing Option
- Contemporary / Flush window options, 1.4 U-value, Energy rating A (WER) (subject to suitable glazing specification)
- Side hung / top hung / fixed light options available



SuperSlim Aluminium Bi-fold Doors



In addition to our standard PANORAMA Aluminium Bi-fold Doors, we also give you the option of PANORAMA SuperSlim Bi-fold Doors.

The PANORAMA SuperSlim bi-fold system is designed to minimise frame sightlines and accentuate the glass area. Sightlines of just 107mm from sash to sash ensures a sleek, contemporary look.

With sash sizes available up to 1200mm wide and 2880mm high per pane, the PANORAMA SuperSlim bi-fold system offers part L compliant U-values as low as 1.4 W/m²K (DER Rating B), when installed with energy efficient glazing, and is also secure to PAS24 (subject to specification).

Available in a number of configurations using up to 6 door leaves, you can specify a design where all the door leaves stack to the same side, or a design where some stack one way and some the other. Choose whether you want the doors to open in or out, and remember that designs with a single traffic door enable you to slip quickly and easily into the garden, while leaving the other doors in place.

An optional moving corner post enables right angled bi-folding doors, including the return, to open out fully with the necessary structural support in place, with the option of a fixed corner.

Precision engineered hardware results in effortless operation making it a pleasure to open up your home to the outside.

TECHNICAL PERFORMANCE

- Market-leading maximum sash size of 1200mm x 2880mm.
- Sash to sash sight lines of just 107mm.
- Multi-point double hook, 6 point locking mechanism.
- PAS24: 2022 compliant for security (subject to specification).
- Glazing thickness up to 44mm.
- Energy efficiency rated U-values as low as 1.4 U W/m²K and Door Energy Rated (DER) B to meet Part L requirements.
- Weather proof tested to BS6375 Part 1 : 2009.
- Frame depth of 73mm.
- Single or dual colour available. Factory powder coated to marine quality as per Qualicoat regulations.
- Up to 120kg per door leaf allowing for large openings.
- Precision engineered rollers results in effortless operation.
- Air permeability class 4 (600 Pa).
- Water tightness class 9A (600 Pa).
- Wind load resistance class A3 (1200; 1/150).
- Trickle vents can be added.
- Option of adjustable jambs for easy adjustment at installation stage.

SuperSlim Aluminium Patio Doors



The PANORAMA SuperSlim sliding patio door is a contemporary, sleek sliding patio door offering double and triple track options.

Designed for significant opening sizes of up to 2500mm x 2630mm per sash, with a SuperSlim interlock of just 25mm. This results in increased glass area and excellent thermal properties of just 1.6 U W/m²K whilst reducing noise, maintaining security and weather-proofing.

The addition of soft closing technology makes for super smooth operation. The sliding function of these doors ensures that none of your rooms valuable interior space is taken up and can also be an ideal solution to integrate two adjacent rooms.

PROFILE OPTIONS

Narrow profiles, engineered with a bottom rail of 42mm width, gives the PANORAMA SuperSlim sliding patio door system almost unrestricted access. There are double and triple track options available.

Numerous opening configurations are achievable, including up to 4 panes with a fixed sash.

GLAZING

PANORAMA SuperSlim sliding patio doors are able to accommodate double and triple glazed units as well as blind in glass. The sophisticated profile design can encompass large sash sizes of up to 2500mm x 2630mm per sash, meaning greater light intake and an impactful vista.

INTERLOCKS

The market-leading 25mm SuperSlim, one-piece interlock is constructed using robust aluminium and can be used with the inline slider, regardless of the size of door. The option of a 50mm interlock is also available.

TECHNICAL PERFORMANCE

- Market-leading maximum sash size of 2500mm x 2630mm per sash.
- Maximum sash weight of 250kg per door leaf.
- Greater visibility with interlock sight lines of just 25mm.
- Double track outer frame depth 120mm.
- Triple track outer frame depth 183mm.
- Optional PAS 24 rating (subject to specification).
- Maximum insulation value – down to 1.6 U W/m²K and Door Energy Rated (DER) C to meet Part L requirements.
- Maximum weather proofing – tested to BS6375 Part 1 : 2009.
- Single or dual colour. Factory powder coated to marine quality as per Qualicoat regulations.



Quality Assurance

Ultimate products are put through regular stringent tests to ensure a consistent high level of quality, but don't just take our word for it...

The British Standards Kitemark is one of the most well known and respected product certification marks in the world and is your reassurance that BSI has checked that your Ultimate PVC-u windows and doors comply with the latest British Standard.



ISO 9001:2015
FM 33147



BS 7412
KM 36014



BS 7412/PAS24
KM 36015



BS 7412/PAS24
KM 590739



BS EN1279 PT2
KM 37462
AG Glass

Quality Assurance ISO 9001:2015

This certification was awarded for providing a high level of Quality Control systems throughout manufacture, administration, health & safety, and products including that of our suppliers such as profile and hardware. We are required to give BSI unrestricted access to our offices and factories and allow random samples to be selected for testing on a regular basis.

BS7412. PVC-U Windows

A standard for PVC-u windows whereby a series of mechanical and manual tests are carried out to ensure windows against weather performance and durability.

Enhanced Window Security (formerly BS7950)

A standard for PVC-u windows whereby a series of mechanical and manual tests are carried out to ensure windows against an accepted level of burglar resistance.

Enhanced Door Security

A standard for PVC-u doors whereby a series of mechanical and manual tests are carried out to ensure doors against an accepted level of burglar resistance.

BS EN1279 PT2. Sealed Units

A thorough and daily test routine for double glazed sealed units is carried out to ensure certification. Tests prove that sealed units adhere to correct dew point, sealant correctness and desiccant moisture absorbency.

BFRC. Window Energy Ratings

Windows are assessed using specific glazing and given a rating from A-G for energy efficiency.



Our Ethos

At Tower we pride ourselves in giving our clients the best support available. To meet this ever-demanding need, we employ professional staff to give advice, to control individual requirements and to supervise all work to a very high standard.

Client satisfaction is a commitment taken very seriously by all our staff and is the foundation that our business has been built on. We take time to understand your needs and offer professional, effective advice.

We will do our utmost to keep to the schedules and deadlines that have been agreed with you and will communicate with you throughout the process. We will be considerate of your daily routines while work takes place.

We will work safely and ensure we keep all areas clean. Above all, it means keeping to the standards of practice and client care that our reputation has been built upon over the last 4 decades.

Accreditation

Tower has always sought to provide the very highest standards of product and service. We are accredited to those organisations within our industry that we believe provide worthwhile assurances to our clients.

We passionately believe that seeing some of our previous projects and meeting existing clients will help give you peace of mind when asking us to undertake the installation of doors and windows in your home. If this is of interest to you, please let us know and we will be happy to organise a visit.

- Ultraframe Ultra Installer
- FENSA Certified Installer
- Insurance Backed Guarantee
- Trustatrader Accredited
- Rockdoor Approved Installer
- Tower Guarantee

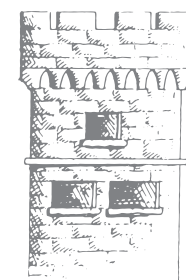

TOWER WINDOWS

Colin Shaw
2 reviews



Had new front door, French windows and glass replaced in front window. Excellent job done by experienced courteous guys who I would thoroughly recommend to anyone. More than happy with work done.

Liam Fivey
8 reviews



Very professional and friendly fitters and the company have been great throughout the process. The guys made little mess, cleaned up and the finish on the windows was top level. Will definitely be using them again when we complete the work on our house.

James Wagstaff
7 reviews



Tower Windows have carried out work at my house on 2 occasions and their work is absolutely excellent...with fully trained professional staff. Their work standards are really First class and staff are so helpful. I would recommend Tower Windows to any prospective customer.

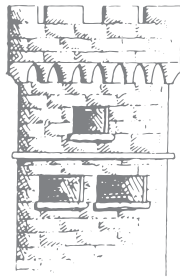

TOWER WINDOWS

TEL: 01978 761076

EMAIL: sales@towerwindows.co.uk

WEB: www.towerwindows.co.uk

SHOWROOM

Wrexham Rd
Cefn-y-Bedd
Wrexham
LL12 9UL

*the***ultimate**[®]
collection

PVC-u and Aluminium Windows and Doors